

AKASISON GUTTER OUTLET L/XL75 FOR CONCRETE GUTTER

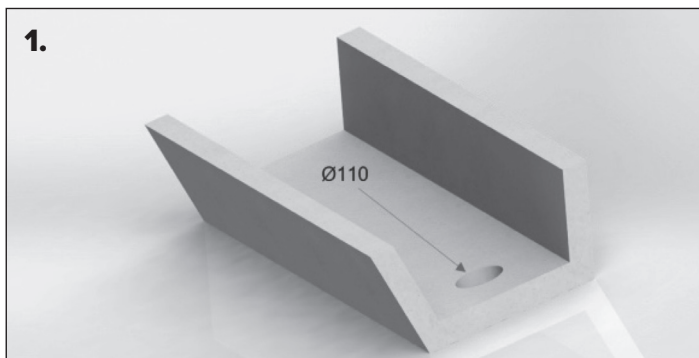

Akasison gutter outlet XL 75



1. Drill hole of Ø 110 mm in the concrete gutter.



2. Insert outlet and mark area covered by outlet and holes for knock in plugs.

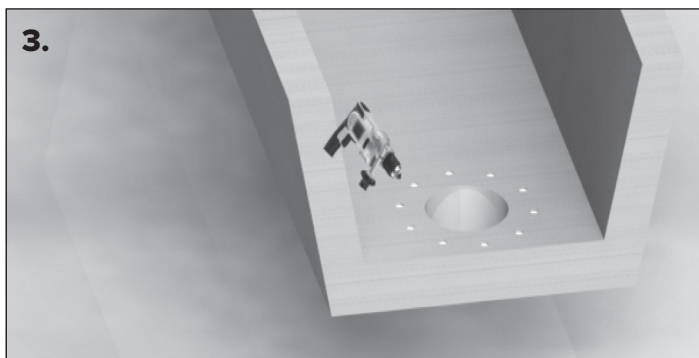

3. Drill hole for knock in plugs Ø 10 mm, 45 mm deep.

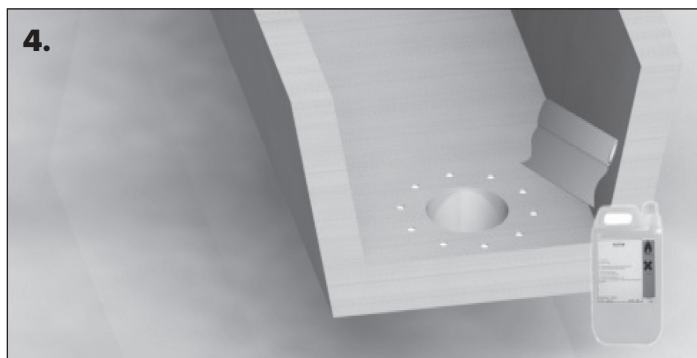

4. Clean and degrease area of outlet. For example use acetone.

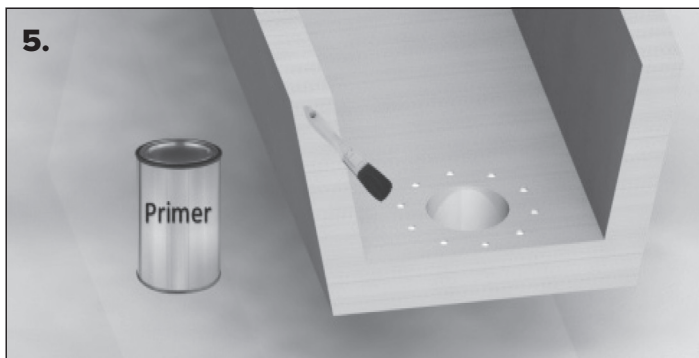

5. Apply primer on concrete gutter on area covered by outlet.

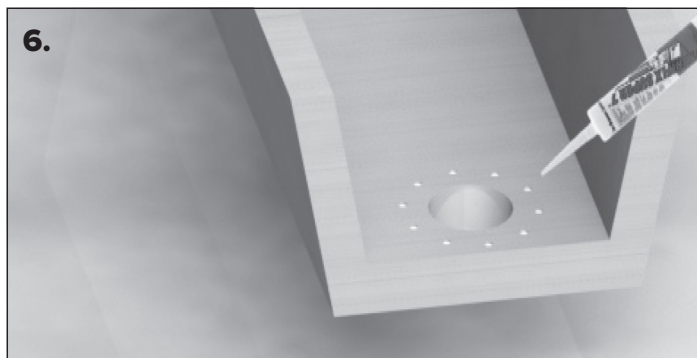

6. Apply kit to make the connection of the gutter and the outlet leaktight.

AKASISON GUTTER OUTLET L/XL75 FOR CONCRETE GUTTER

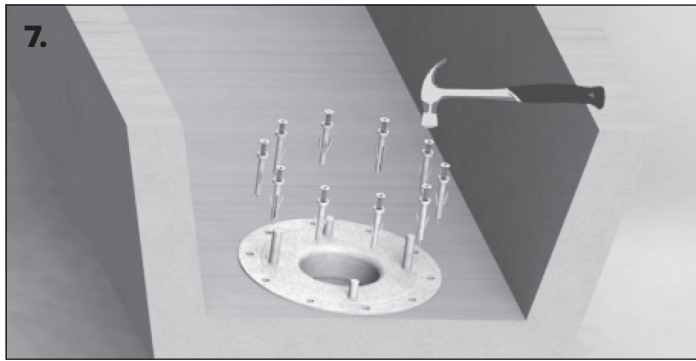

Fasten outlet with the knock in plugs.

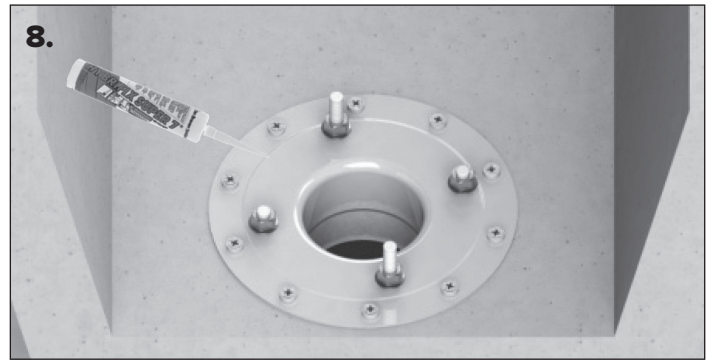

Kit the gutter around the outlet and the screws.

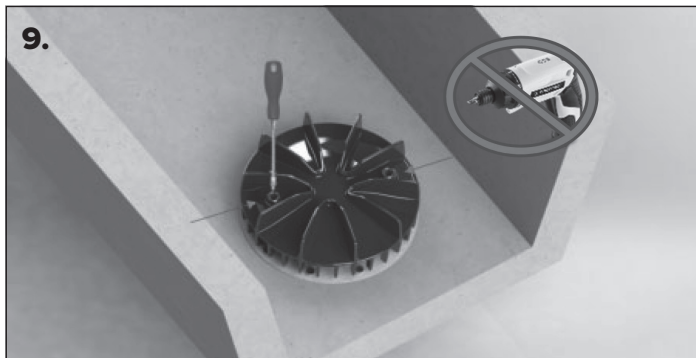

Mount the air baffle with the supplied screws. Do not use an electric screwdriver.