



Nicoll TECHTAN[®] hemelwaterafvoer

voor rondom het huis

Nicoll
een **alixis** merk

alixis



Inhoud

Een nieuwe generatie dakgoten en afvoerbuizen	06
Zeker in weer en wind dankzij TECHTAN®	08
Duurzaam en betrouwbaar	09
Voor elk dakproject een bijpassende goot	11
Mastgoot (halfmond)	12
Vodalis	21
Ovation	24
Afvoerputten	32



Aliaxis, wereldwijd toonaangevend

Als producent van leidingsystemen bieden we oplossingen voor de wereldwijde uitdagingen op het gebied van water en versnellen we de overgang naar schone energie. Water vormt de kern van ons bestaan.

We bouwen voort op een sterke basis en vertrouwen erop dat onze teams deze kostbare hulpbron beschermen en toegang tot schoon water mogelijk maken. Dankzij onze ruim 14.000 medewerkers in meer dan 40 landen voldoen onze leidingsystemen aan de meest veeleisende behoeften van onze klanten in de bouw-, infrastructuur- en industriesector.

Nicoll TECHTAN® hemelwaterafvoer

Wateroverlast. Vroeg of laat krijgt iedereen er een keer mee te maken. De kans op langdurige, hevige regenbuien is door klimaatverandering alleen maar groter geworden. Efficiënte afwatering is daarom van groot belang. Daarnaast willen steeds meer gemeenten dat men zelf zorgt voor de opvang en afvoer van water om zo het gemeenteriool minder te belasten.

Wij hebben een ruim assortiment samengesteld dat bestaat uit dakgoten, afvoerbuizen en afvoerputten voor rondom de woning. Nicoll TECHTAN® is een ultrabestendig composiet dat een perfect alternatief biedt voor PVC, zink en andere (kunststof) materialen. Al onze producten zijn bovendien 100% te recyclen. De ontwerpvrijheid biedt de mogelijkheid om de systemen te integreren in vrijwel ieder ontwerp.



alixis.nl



alixis

Een nieuwe generatie kunststof dakgoten en afvoerbuizen

Ben je op zoek naar een duurzaam, betaalbaar en esthetisch alternatief voor zink, aluminium of traditioneel PVC? Ons productportfolio van Nicoll **TECHTAN**[®] combineert al deze eigenschappen. Het portfolio kent vele maten en profielen en je kunt kiezen uit een reeks kleuren. Hierdoor is het geschikt voor alle stijlen van architectuur, of het nu om nieuwbouw of renovatie gaat. Er is altijd een variant die bij de uitstraling van het gebouw past. Van de traditionele vormgegeven mastgoot halffrond tot aan de elegante kroonlijstbakgoot, van standaard grijs tot stijlvol zwart.

Wit RAL 9010	Lichtgrijs RAL 7047	Beige RAL 1015	Bruin RAL 8017	Donkergrijs RAL 7037	Antraciet RAL 7016	Zwart RAL 9011
------------------------	-------------------------------	--------------------------	--------------------------	--------------------------------	------------------------------	--------------------------



Mastgoot (halffrond): de klassieke dakgoot

Ideaal voor traditionele architectuur en is verkrijgbaar in 3 modellen:

- LG33: bijzonder geschikt voor gebieden met hevige regenval en grote dakoppervlakken.
- LG25: de perfecte oplossing voor buitenverblijven, overkappingen en poolhouses
- LG16: gemaakt voor kleine dakoppervlakken, zoals tuinhuisjes en veranda's

De mastgoot is aanpasbaar aan de meeste dakbedekkingsmaterialen.

Vodalis: vernieuwde variant van de klassieke dakgoot

Nicoll betrok dakdekkers bij de ontwikkeling van de **VODALIS**[®] dakgoot in **TECHTAN**[®]. Het heeft een uniek profiel voor 2 toepassingen : gekoppeld aan een buis Ø 80, verandert deze in een LG25 goot; gecombineerd met een buis Ø 100, heeft het de prestaties van een LG33 goot.

Met een openingsmaat van 140 mm en regenpijpen Ø 80 of Ø 100 biedt **VODALIS**[®] een hoog watercapaciteit.



Ovation: subtiel ontwerp met hoge performance

Het **OVATION**[®] dakgootsysteem in **TECHTAN**[®], heeft een ingetogen en vloeiend design, passend in alle bouwstijlen. Dankzij de volledig onzichtbare haak is **OVATION**[®] uiterst discreet, terwijl de details en afwerking van het dak worden benadrukt. **OVATION**[®] garandeert een optimale doorstroomcapaciteit en snelheid. Met een centrale uitlaatstuk kan het LG28-model 65 m² plat dak onderhouden en de LG38 tot 100 m² plat dak.

Vodalis



Ovation



Mastgoot halfrond



Zeker in weer en wind dankzij **TECHTAN**[®]

De Nicoll dakgoten en afvoerbuizen zijn gemaakt van **TECHTAN**[®], een ultrabestendig composiet dat 100% te recyclen is. Het biedt een perfect alternatief voor traditioneel PVC, zink en andere (kunststof) materialen.

Deze dakgoten worden door co-extrusie geproduceerd om uitzetting door opwarming te minimaliseren. Een exclusieve formulering maakt de goten bewezen UV-, vorst-, corrosie- en schokbestendig.

TECHTAN[®] vergeleken met traditioneel PVC:

- duurzaam door een uitstekende kleurvastheid en levensduur.
- sterker, veilig en betrouwbaar in weer en wind:
30 jaar garantie op **TECHTAN**[®]!

TECHTAN[®] vergeleken met zink:

- net zo resistent.
- voordeliger en lichter.

TECHTAN[®] vergeleken met aluminium:

- hogere weerstand van de afvoerbuis.
- eenvoudigere installatie.



Duurzaam en betrouwbaar

Het hele Nicoll **TECHTAN**[®] assortiment is uitgebreid getest en voldoet aan de Europese norm NF EN 607.



Duurzaam

100% recyclebaar en met een garantie van 30 jaar op Nicoll **TECHTAN**[®]. Raadpleeg de algemene garantievoorwaarden op alixis.nl.



UV-bestendig en kleurvast

Klimaatverandering zorgt ook voor meer UV-straling. De dakgoten van Nicoll **TECHTAN**[®] hebben een uitstekende kleurvastheid en schokweerstand, ook na jarenlange blootstelling aan felle zon.



Gegarandeerd bestand tegen extreme weersomstandigheden en schokken

Hoge weerstand tegen vorst, sneeuw en hagel, windsnelheden tot 200 km/u of extreme temperaturen (- 40° tot + 60°C).



Groot installatiegemak

De onderdelen zijn licht en eenvoudig in elkaar te verlijmen. Geen voormontage nodig, maar uiteraard wel mogelijk. Past op alle dakvormen en -materialen.



Weerstand tegen corrosie

Hoge weerstand tegen corrosie-afbraak door vervuiling en vrijkomende zuren.



Supersterk

Bestand tegen schokken van vallende ladders, takken, ballen van spelende kinderen, enz.



Bekijk de video van de installatie van Nicoll **TECHTAN**[®]. Maak kennis met Alex, onze topinstallateur van dakgootsystemen op: www.alixis.nl/dakgoten

Ovation



Mastgoot halfrond



Vodalis

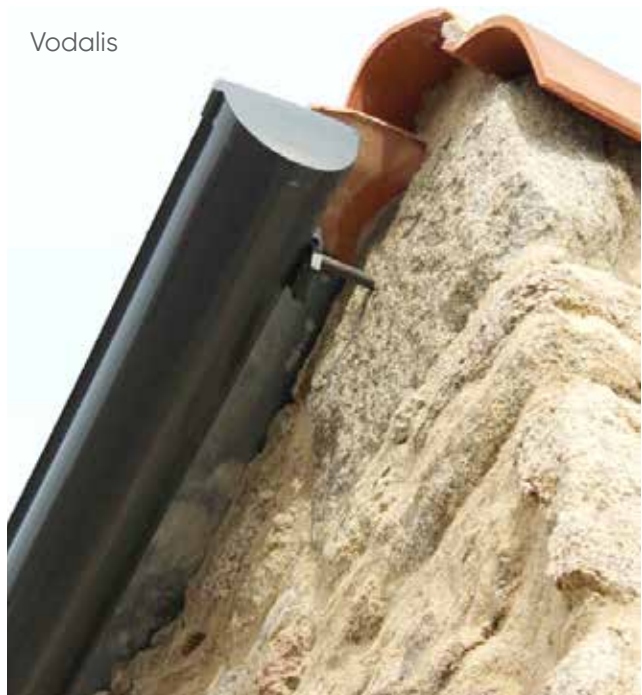

Voor elk dakproject een bijpassende goot

	Traditionele mastgoot halfrond			Vernieuwde traditionele vorm van dakgoot	Een vernieuwend en elegant systeem	
	Mastgoot halfrond			Vodalis	Ovation	
Max. dakoppervlak (in m² horizontaal geprojecteerd per centraaluitloop)	20 m ²	65 m ²	100 m ²	Van 65 tot 100 m ² Afhankelijk van het soort centraal-uitloop en hemelwaterafvoerbuīs	65 m ²	100 m ²
Profiel dakgoot						
Basisreferentie	LG16 Met rubber inlage	LG25 Te lijmen en met rubber inlage	LG33 Te lijmen en met rubber inlage	LG29 Te lijmen	LG28 Te lijmen	LG38 Te lijmen
Beschikbare kleuren	<div style="display: flex; flex-direction: column; gap: 5px;"> <div style="background-color: white; padding: 2px;">Wit RAL 9010</div> <div style="background-color: #d3d3d3; padding: 2px;">Lichtgrijs RAL 7047</div> <div style="background-color: #800000; padding: 2px;">Bruin RAL 8017</div> <div style="background-color: #404040; padding: 2px;">Antraciet RAL 7016</div> </div>	<div style="display: flex; flex-direction: column; gap: 5px;"> <div style="background-color: white; padding: 2px;">Wit RAL 9010</div> <div style="background-color: #d3d3d3; padding: 2px;">Lichtgrijs RAL 7047</div> <div style="background-color: #800000; padding: 2px;">Beige RAL 1015</div> <div style="background-color: #800000; padding: 2px;">Bruin RAL 8017</div> <div style="background-color: #696969; padding: 2px;">Donkergrijs RAL 7037</div> <div style="background-color: #404040; padding: 2px;">Antraciet RAL 7016</div> <div style="background-color: #000000; padding: 2px;">Zwart RAL 9011</div> </div>	<div style="display: flex; flex-direction: column; gap: 5px;"> <div style="background-color: white; padding: 2px;">Wit RAL 9010</div> <div style="background-color: #d3d3d3; padding: 2px;">Lichtgrijs RAL 7047</div> <div style="background-color: #800000; padding: 2px;">Bruin RAL 8017</div> <div style="background-color: #404040; padding: 2px;">Antraciet RAL 7016</div> </div>	<div style="display: flex; flex-direction: column; gap: 5px;"> <div style="background-color: white; padding: 2px;">Wit RAL 9010</div> <div style="background-color: #800000; padding: 2px;">Bruin RAL 8017</div> <div style="background-color: #404040; padding: 2px;">Antraciet RAL 7016</div> <div style="background-color: #000000; padding: 2px;">Zwart RAL 9011</div> </div>	<div style="display: flex; flex-direction: column; gap: 5px;"> <div style="background-color: white; padding: 2px;">Wit RAL 9010</div> <div style="background-color: #d3d3d3; padding: 2px;">Beige RAL 1015</div> <div style="background-color: #800000; padding: 2px;">Bruin RAL 8017</div> <div style="background-color: #404040; padding: 2px;">Antraciet RAL 7016</div> <div style="background-color: #000000; padding: 2px;">Zwart RAL 9011</div> </div>	<div style="display: flex; flex-direction: column; gap: 5px;"> <div style="background-color: white; padding: 2px;">Wit RAL 9010</div> <div style="background-color: #404040; padding: 2px;">Antraciet RAL 7016</div> <div style="background-color: #000000; padding: 2px;">Zwart RAL 9011</div> </div>
Zie pagina	12	14	18	21	24	27

De keuze van de hemelwaterafvoerbuīs:

	LG16	LG25	LG33	LG29	LG28	LG38			
Vorm buīs									
Ø buīs	50	80	100	80	100	80	90 x 56	100	105 x 76
Zie pagina	13	15	19	22	22	25	25	28	28

LG16 Mastgoot halfrond met rubber inlage

Profiel dakgoot



LG16

Lengte	Lichtgrijs	Wit	Bruin	Antraciet
2 m	LG162	LG162B	LG162M	LG162A
4 m	LG16	LG16B	LG16M	LG16A

Hulpstukken voor goot met rubber inlage



NC16



JN16



AI16



AE16



FCN16

Omschrijving	Ø	Lichtgrijs	Wit	Bruin	Antraciet
Uitlaatstuk centraal met rubber inlage	50	NC16	NC16B	NC16M	NC16A
Verbindingsstuk met rubber inlage		JN16	JN16B	JN16M	JN16A
Hoekstuk binnen		AI16	AI16B	AI16M	AI16A
Hoekstuk buiten		AE16	AE16B	AE16M	AE16A
Eindeksel universeel voor uitlaatstuk centraal		FCN16	FCN16B	FCN16M	FCN16A

Gootbeugels



GB1



GO4



2EMO4

Omschrijving	Lichtgrijs	Wit	Bruin	Antraciet
Gootbeugel	GB1	GB1B	GB1M	GB1A
Gootbeugel met verstelbare dakhaak	GO4	GO4B	GO4M	GO4A
Bevestigingsstuk golfplaten	2EMO4		2EMO4M	2EMO4A

Afvoerbuizen



TD50A

Omschrijving	Ø	Lichtgrijs	Wit	Bruin	Antraciet
Afvoerbuis 2 m gemoft	50				TD502PA
Afvoerbuis 4 m gemoft	50	TD50P	TD50PB	TD50PM	TD50PA
Afvoerbuis 4 m niet gemoft	50	TD50	TD50B	TD50M	TD50A

Hulpstukken voor afvoerbuizen



CJ4GT



CJ8GT



CJ88GT



BJ16GT



ZJGT



JJGT



NPC50

Omschrijving	Ø	Lichtgrijs	Wit	Bruin	Antraciet
Bocht mof-spig 45°	50	CJ4GT	CJ4GTB	CJ4GTM	CJ4GTA
Bocht mof-mof 45°	50				CJ44GTA
Bocht mof-spig 67°30	50	CJ6GT	CJ6GTB	CJ6GTM	
Bocht mof-mof 67°30	50				CJ66GTA
Bocht mof-spig 87°30	50	CJ8GT	CJ8GTB	CJ8GTM	
Bocht mof-mof 87°30	50	CJ88GT			CJ88GTA
T-stuk mof-spig 67°30	50	BJ16GT	BJ16GTB	BJ16GTM	BJ166GTA
Verbindingsmof mof-spig	50	ZJGT	ZJGTB	ZJGTM	
Verbindingsmof mof-mof verjongd	50	JJGT	JJGTB	JJGTM	JJGTA
Uitloop met bladvanger	50	NPC50			

Beugels



CO50GB



CO50GT

Omschrijving	Ø	Lichtgrijs	Wit	Bruin	Antraciet
Clipbeugel P.7/100	50	CO50GB *	CO50BB *	CO50GBM *	CO50GBA *
Clipbeugel P.7/150	50	CO50GT *	CO50GTB *	CO50GTM *	CO50GTA *

* Niet uit TECHTAN[®] gemaakt

LG25 Mastgoot halfrond te lijmen of met rubber inlage

Profiel dakgoot



LG25

Lengte	Lichtgrijs	Donkergrijs	Wit	Beige	Bruin	Antraciet	Zwart
2 m	LG252		LG252B	LG252S	LG252M	LG252A	LG252N
4 m	LG25	LG25F	LG25B	LG25S	LG25M	LG25A	LG25N

Hulpstukken voor goot te lijmen



NAD25

NAC25

JNC25

JND25

ANC25

ANC525

FCG25

FCN25

Omschrijving	Ø	Lichtgrijs	Donkergrijs	Wit	Beige	Bruin	Antraciet	Zwart
Expansie centraaluitloop spie	80	NAD25		NAD25B	NAD25S	NAD25M	NAD25A	NAD25N
Centraaluitloop spie	80	NAC25		NAC25B	NAC25S	NAC25M	NAC25A	NAC25N
Verbindingsstuk		JNC25		JNC25B	JNC25S	JNC25M	JNC25A	JNC25N
Expansiestuk		JND25		JND25B	JND25S	JND25M	JND25A	JND25N
Binnen-/buitenhoekstuk 90°		ANC25		ANC25B	ANC25S	ANC25M	ANC25A	ANC25N
Binnen-/buitenhoekstuk 135°		ANC525		ANC525B	ANC525S	ANC525M	ANC525A	ANC525N
Eindstuk voor goot		FCG25	FCG25F	FCG25B	FCG25S	FCG25M	FCG25A	FCG25N
Eindstuk voor centraaluitloop		FCN25		FCN25B	FCN25S	FCN25M	FCN25A	FCN25N

Hulpstukken voor goot met rubber inlage



NC25

JN25

AI25

AE25

FGJ25

FNJ25

Omschrijving	Ø	Lichtgrijs	Donkergrijs	Wit	Beige	Bruin	Antraciet	Zwart
Centraaluitloop spie	80	NC25	NC25F	NC25B	NC25S	NC25M	NC25A	NC25N
Verbindingsstuk		JN25	JN25F	JN25B	JN25S	JN25M	JN25A	JN25N
Binnenhoekstuk 90°		AI25	AI25F	AI25B	AI25S	AI25M	AI25A	AI25N
Buitenhoekstuk 90°		AE25	AE25F	AE25B	AE25S	AE25M	AE25A	AE25N
Eindstuk voor goot		FGJ25		FGJ25B	FGJ25S	FGJ25M	FGJ25A	FGJ25N
Eindstuk voor centraaluitloop		FNJ25		FNJ25B	FNJ25S	FNJ25M	FNJ25A	FNJ25N

Gootbeugels



Omschrijving	Lichtgrijs	Donkergrijs	Wit	Beige	Bruin	Antraciet	Zwart
Gootbeugel	GB25P	GB25PF	GB25PB	GB25PS	GB25PM	GB25PA	GB25PN
Gootbeugel voor metalen bevestigingsmiddelen	BERGO25P		BERGO25B	BERGO25S	BERGO25M		BERGO25N
Gootbeugel verborgen ophanging	BHGB25		BHGB25B	BHGB25S	BHGB25M	BHGB25A	BHGB25N
Golfdakbeugel	GO25PM *		GO25PMB *	GO25PMS *	GO25PMM *	GO25PMA *	GO25PMN *
Kit gootbeugel met metalen bevestigingsmiddelen	GO25P *						
Gootbeugel met dakhaak	GO25PBAM *		GO25PBAMB *	GO25PBAMS *	GO25PBAMM *	GO25PBAMA *	GO25PBAMN *
Sneeuwhaak		CN25F *					
Gootbeugel verstelbaar	GCO25P		GCO25PB	GCO25PS			

Afvoerbuizen



TD80

Omschrijving	Ø	Lichtgrijs	Donkergrijs	Wit	Beige	Bruin	Antraciet	Zwart
Afvoerbuis 3 m gemoft	80	TD803P		TD803PB	TD803PS	TD803PM	TD803PA	TD803PN
Afvoerbuis 3 m niet gemoft	80						TD803A	TD803N
Afvoerbuis 4 m gemoft	80	TD80P	TD80PF	TD80PB	TD80PS	TD80PM	TD80PA	TD80PN
Afvoerbuis 4 m niet gemoft	80	TD80		TD80B	TD80S	TD80M	TD80A	TD80N

Hulpstukken voor afvoerbuizen



CR4GT



CR8GT1



SR3GT



CR66GT



BR16GT



ZRGT

Omschrijving	Ø	Lichtgrijs	Donkergrijs	Wit	Beige	Bruin	Antraciet	Zwart
Bocht mof-spie 20°	80	CR2GT		CR2GTB	CR2GTS	CR2GTM	CR2GTA	CR2GTN
Bocht mof-spie 45°	80	CR4GT	CR4GTF	CR4GTB	CR4GTS	CR4GTM	CR4GTA	CR4GTN
Bocht mof-spie 67°30	80	CR6GT		CR6GTB	CR6GTS	CR6GTM	CR6GTA	CR6GTN
Bocht mof-spie 87°30	80	CR8GT	CR8GTF	CR8GTB	CR8GTS	CR8GTM	CR8GTA	CR8GTN
Bocht mof-spie 15°	80	SR1GT		SR1GTB	SR1GTS	SR1GTM	SR1GTA	
Bocht mof-spie 30°	80	SR3GT		SR3GTB	SR3GTS	SR3GTM	SR3GTA	
Bocht mof-mof 45°	80	CR44GT		CR44GTB	CR44GTS	CR44GTM		
Bocht mof-mof 67°30	80	CR66GT		CR66GTB	CR66GTS	CR66GTM	CR66GTA	CR66GTN
Bocht mof-mof 87°30	80	CR88GT		CR88GTB	CR88GTS			
Bocht mof-spie verjongd 45°	80	CR4GT1	CR4GT1F	CR4GT1B	CR4GT1S	CR4GT1M	CR4GT1A	CR4GT1N
Bocht mof-spie verjongd 87°30	80	CR8GT1	CR8GT1F	CR8GT1B	CR8GT1S	CR8GT1M	CR8GT1A	CR8GT1N
Bocht mof-spie verjongd 67°30	80	CR6GT1	CR6GT1F	CR6GT1B	CR6GT1S	CR6GT1M	CR6GT1A	CR6GT1N
T-stuk mof-spie verjongd 67°30	80		BR16GT1F	BR16GT1B	BR16GT1S	BR16GT1M	BR16GT1A	BR16GT1N
T-stuk mof-spie 67°30	80	BR16GT	BR16GTF	BR16GTB	BR16GTS	BR16GTM	BR16GTA	BR16GTN
T-stuk mof-spie 87°30	80	BR18GT		BR18GTB	BR18GTS			
Verbindingsmof mof-spie verjongd	80	JRGT	JRGTf	JRGTB	JRGTs	JRGTm	JRGTa	JRGTn
Verbindingsmof mof-spie	80	ZRGT	ZRGTf	ZRGTB	ZRGTs	ZRGTm	ZRGTa	ZRGTn
Overgangstuk stadsuitloop mof-spie verjongd	80			ZR95B	ZR95S	ZR95M	ZR95A	ZR95N

Beugels



CO80GB



CORGB

Omschrijving	Ø	Lichtgrijs	Donkergrijs	Wit	Beige	Bruin	Antraciet	Zwart
Clipbeugel p.7/100	80	CO80GB *		CO80GTB *	CO80GTS *			
Pijpbeugel p.7/100	80	CORGB *		CORGBB *	CORGBS *	CORGBM *	CORGBA *	CORGBN *
Pijpbeugel p.7/150	80	CORGT *		CORGTB *	CORGTS *	CORGIAM *	CORGTA *	CORGTN *
Pijpbeugel verborgen bevestiging 7/150	80	CORGT1 *		CORGT1B *	CORGT1S *	CORGT1M *	CORGT1A *	CORGT1N *
Clipbeugel M6	90x56			CONGTB *	CONGTS *		CONGTA *	CONGTN *

Accessoires voor afvoerbuizen



RWS801



PAF801



REPTD80



BAO80



NPC80

Omschrijving	Ø	Lichtgrijs	Donkergrijs	Wit	Beige	Bruin	Antraciet	Zwart
Uitloop gebogen	80	RWS801		RWS801B	RWS801S	RWS801M	RWS801A	RWS801N
Overgangsstuk naar rond met voetplaat mof-universeel 90-100-110-125 verjongd	90x56			PCU95B	PCU95S	PCU95M	PCU95A	PCU95N
Ondereind 1 meter lang	80	DDF10R		DDF10RB	DDF10RS			
Bladvanger mof-spie verjongd (in zakje)	80	PAF801	PAF801F	PAF801B	PAF801S	PAF801M	PAF801A	PAF801N
Bladvanger	80			1PAF801B		1PAF801M	1PAF801A	1PAF801N
Regentonvulautomaat met 1" aansluiting mof-spie verjongd	80	REPTD80		REPTD80B	REPTD80S	REPTD80M	REPTD80A	REPTD80N
Verzamelbak	80	JAM80		JAM80B	JAM80S	JAM80M	JAM80A	JAM80N
Vergaarbak met overloop (optioneel)	80	BAO80		BAO80B	BAO80S	BAO80M	BAO80A	BAO80N
Uitloop met bladvanger	80	NPC80						

Ken je deze Nicoll probleemoplossers voor hemelwaterafvoer?



De vergaarbak

Voor een esthetische en efficiënte hemelwaterafvoer van balkons en platte daken.

- Uit TECHTAN[®] gemaakt: ultrabestendig, en ook met 30 jaar garantie!
- Eenvoudige installatie.
- Hoge afvoercapaciteit.
- Met overloop waarschuwing om verstoppingen te voorkomen.

De bladvanger

- Houdt bladeren en andere vervuiling tegen die door de afvoerbuizen gaan.
- Gemakkelijk schoon te maken.
- Opent en sluit met een simpele draai.
- Integreert zich harmonieus in de afvoerbuizen.



LG33 Mastgoot halfrond te lijmen of met rubber inlage

Profiel dakgoot



LG33

Lengte	Lichtgrijs	Wit	Bruin	Antraciet
4 m	LG33	LG33B	LG33M	LG33A

Hulpstukken voor goot te lijmen



NAD333



ANC33



ANC533



JND33



JNC33



FCG33

Omschrijving	Ø	Lichtgrijs	Wit	Bruin	Antraciet
Expansie centraaluitloop spie	100	NAD333	NAD333B	NAD333M	NAD333A
Expansie centraaluitloop spie	125	NAD333	NAD333B	NAD333M	NAD333A
Centraaluitloop spie	100	NAC333	NAC333B	NAC333M	NAC333A
Centraaluitloop spie	125	NAC333	NAC333B		
Binnen-/buitenhoekstuk 135°		ANC533	ANC533B	ANC533M	ANC533A
Binnen-/buitenhoekstuk 90°		ANC33	ANC33B	ANC33M	ANC33A
Expansiestuk		JND33	JND33B	JND33M	JND33A
Verbindingsstuk		JNC33	JNC33B	JNC33M	JNC33A
Eindstuk voor centraaluitloop		FCN33	FCN33B	FCN33M	FCN33A
Eindstuk voor goot		FCG33	FCG33B	FCG33M	FCG33A

Hulpstukken voor goot met rubber inlage



NC333



AE33



AI33



JN33

Omschrijving	Ø	Lichtgrijs	Wit	Bruin	Antraciet
Centraaluitloop spie	125	NC333			NC333A
Centraaluitloop spie	100	NC33			
Binnenhoekstuk 90°		AI33			
Buitenhoekstuk 90°		AE33			
Verbindingsstuk		JN33	JN33B		

Gootbeugels



BERGO33P



GO33PM



GB33P

Omschrijving	Lichtgrijs	Wit	Bruin	Antraciet
Gootbeugel voor metalen bevestigingsmiddelen	BERGO33P	BERGO33B		BERGO33A
Gootbeugel met dakhaak	GO33PBAM			
Golfdakbeugel met metalen bevestigingsmiddelen	GO33PM	GO33PMB	GO33PMM	GO33PMA
Gootbeugel	GB33P	GB33PB	GB33PM	GB33PA

Afvoerbuizen



TD100

Omschrijving	Ø	Lichtgrijs	Wit	Bruin	Antraciet
Afvoerbuis 4 m niet gemoft	100	TD100	TD100B	TD100M	TD100A
Afvoerbuis 4 m gemoft	100	TD100P	TD100PB	TD100PM	TD100PA
Afvoerbuis 3 m gemoft	100	TD1003P	TD1003PB	TD1003PM	TD1003PA

Beugels



COTGT1



COTGB

Omschrijving	Ø	Lichtgrijs	Wit	Bruin	Antraciet
Pijpbeugel	100		COXGTB *		COXGTA *
Pijpbeugel met verborgen bevestiging	100	COTGT1 *	COTGT1B *	COTGT1M *	COTGT1A *
Pijpbeugel	100	COTGB *	COTGBB *	COTGBM *	COTGBA *
Pijpbeugel	125	COXGB *			
Clipbeugel	100	CO100GB *			
Pijpbeugel p.6/100	100	COTG1A *	COTG1AB *	COTG1AM *	COTG1AA *

* Niet uit TECHTAN[®] gemaakt

Hulpstukken voor afvoerbuizen



CT6GT



CT6GT1



CX8GT



BX16GT



JTGT



ZTGT

Omschrijving	Ø	Lichtgrijs	Wit	Bruin	Antraciet
Bocht mof-spie 20°	100	CT2GT	CT2GTB		
Bocht mof-spie 45°	100	CT4GT	CT4GTB	CT4GTM	CT4GTA
Bocht mof-spie 45°	100		CT4GT1B	CT4GT1M	CT4GT1A
Bocht mof-spie 67°30	100	CT6GT	CT6GTB	CT6GTM	CT6GTA
Bocht mof-spie 87°30	100	CT8GT	CT8GTB	CT8GTM	CT8GTA
Bocht mof-spie verjongd 87°30	100	CT8GT1	CT8GT1B	CT8GT1M	CT8GT1A
Bocht mof-spie verjongd 67°30	100	CT6GT1	CT6GT1B	CT6GT1M	CT6GT1A
Bocht mof-spie 45°	125	CX4GT	CX4GTB		CX4GTA
Bocht mof-spie 67°30	125	CX6GT	CX6GTB		CX6GTA
Bocht mof-spie 87°30	125	CX8GT	CX8GTB		CX8GTA
T-stuk mof-spie 67°30	100	BT16GT	BT16GTB	BT16GTM	BT16GTA
T-stuk mof-spie verjongd 67°30	100		BT16GT1B	BT16GT1M	BT16GT1A
T-stuk mof-spie 45°	100				
T-stuk mof-spie 87°30	100				
T-stuk mof-spie 67°30	125	BX16GT	BX16GTB		BX16GTA
Verbindingsmof mof-mof	100	JTGT	JTGTB	JTGTM	JTGTA
Verbindingsmof mof-mof	125	JXGT	JXGTB		JXGTA
Verbindingsmof mof-spie	100	ZTGT	ZTGTB	ZTGTM	ZTGTA
Verbindingsmof mof-spie	125	ZXGT	ZXGTB		ZXGTA

Accessoires voor afvoerbuizen



REPF100



BAO100



RE338



JAM100



DDF10T

Omschrijving	Ø	Lichtgrijs	Wit	Bruin	Antraciet
Regentonnulautomaat met 1" aansluiting mof-spie verjongd	100	REPF100	REPF100B	REPF100M	REPF100A
Uitloop gebogen	100		RWS1001B	RWS1001M	RWS1001A
Concentrisch verloop	100	RE338	RE338GTB	RE338M	RE338A
Vergaarbak met overloop (optioneel)	100	BAO100	BAO100B	BAO100M	BAO100A
Binnen-/buitenhoekstuk 135°		ANC533	ANC533B	ANC533M	ANC533A
Binnen-/buitenhoekstuk 90°		ANC33	ANC33B	ANC33M	ANC33A
Verzamelbak	100	JAM100	JAM100B	JAM100M	JAM100A
Ondereind 1 meter lang	100	DDF10T			DDF10T1A

LG29 Vodalis te lijmen

Profiel dakgoot



LG29A

Lengte	Wit	Bruin	Antraciet	Zwart
2 m	LG292B	LG292M	LG292A	
4 m	LG29B	LG29M	LG29A	LG29N

Hulpstukken voor goot te lijmen



NAD29A

JNC29A

JND29A

AIC29A

AIC295A

AEC29A

AEC295A

FG29A

Omschrijving	Ø	Wit	Bruin	Antraciet	Zwart
Expansie centraaluitloop	80	NAD29B	NAD29M	NAD29A	NAD29N
Expansie centraaluitloop	100	NADT29B	NADT29M	NADT29A	NADT29N
Verbindingsstuk		JNC29B	JNC29M	JNC29A	JNC29N
Expansiestuk		JND29B	JND29M	JND29A	JND29N
Binnenhoekstuk 90°		AIC29B	AIC29M	AIC29A	AIC29N
Binnenhoekstuk 135°		AIC295B	AIC295M	AIC295A	AIC295N
Buitenhoekstuk 90°		AEC29B	AEC29M	AEC29A	AEC29N
Buitenhoekstuk 135°		AEC295B	AEC295M	AEC295A	AEC295N
Eindstuk voor goot links		FG29B	FG29M	FG29A	FG29N
Eindstuk voor goot rechts		FD29B	FD29M	FD29A	FD29N
Eindstuk met dichting voor goot links		FGJ29B	FGJ29M		
Eindstuk met dichting voor goot rechts		FDJ29B	FDJ29M		

Gootbeugels



GB29PA



CRONO29B

Omschrijving	Wit	Bruin	Antraciet	Zwart
Gootbeugel	GB29PB	GB29PM	GB29PA	GB29PN
Gootbeugel verborgen ophanging met voorgemonteerde schroef	CRONO29B *		CRONO29A *	
Gootbeugel verborgen ophanging	INVISI29B *			

* Niet uit TECHTAN® gemaakt

Afvoerbuizen



TD803PA

Omschrijving	Ø	Wit	Bruin	Antraciet	Zwart
Afvoerbuis 3 m gemoft	80	TD803PB	TD803PM	TD803PA	TD803PN
Afvoerbuis 3 m niet gemoft	80			TD803A	TD803N
Afvoerbuis 4 m gemoft	80	TD80PB	TD80PM	TD80PA	TD80PN
Afvoerbuis 4 m niet gemoft	80	TD80B	TD80M	TD80A	TD80N
Afvoerbuis 4 m niet gemoft	100	TD100B	TD100M	TD100A	TD100N
Afvoerbuis 4 m gemoft	100	TD100PB	TD100PM	TD100PA	TD100PN
Afvoerbuis 3 m gemoft	100	TD1003PB	TD1003PM	TD1003PA	

Hulpstukken voor afvoerbuizen



CR66GTA



CR8GT1A



CR4GT1A



SR1GTA



BR16GT1A



ZRGTA

Omschrijving	Ø	Wit	Bruin	Antraciet	Zwart
Bocht mof-spie 20°	80	CR2GTB	CR2GTM	CR2GTA	CR2GTN
Bocht mof-spie 45°	80	CR4GTB	CR4GTM	CR4GTA	CR4GTN
Bocht mof-spie 45°	100	CT4GTB	CT4GTM	CT4GTA	
Bocht mof-spie 67°30	80	CR6GTB	CR6GTM	CR6GTA	CR6GTN
Bocht mof-spie 67°30	100	CT6GTB	CT6GTM	CT6GTA	
Bocht mof-spie 87°5	80	CR8GTB	CR8GTM	CR8GTA	CR8GTN
Bocht mof-mof 45°	80	CR44GTB	CR44GTM		
Bocht mof-mof 67°30	80	CR66GTB	CR66GTM	CR66GTA	CR66GTN
Bocht mof-mof 87°30	80	CR88GTB			
Bocht mof-spie verjongd 45°	80	CR4GT1B	CR4GT1M	CR4GT1A	CR4GT1N
Bocht mof-spie verjongd 45°	100	CT4GT1B	CT4GT1M	CT4GT1A	CT4GT1N
Bocht mof-spie verjongd 67°30	80	CR6GT1B	CR6GT1M	CR66GTA	CR6GT1N
Bocht mof-spie verjongd 67°30	100	CT6GT1B	CT6GT1M	CT6GT1A	CT6GT1N
Bocht mof-spie verjongd 87°5	80	CR8GT1B	CR8GT1M	CR8GT1A	CR8GT1N
Bocht mof-spie verjongd 87°5	100	CT8GT1B	CT8GT1M	CT8GT1A	CT8GT1N
Bochtdeel mof-spie 15°	80	SR1GTB	SR1GTM	SR1GTA	
Bochtdeel mof-spie 30°	80	SR3GTB	SR3GTM	SR3GTA	
T-stuk mof-spie verjongd 67°30	80	BR16GT1B	BR16GT1M	BR16GT1A	BR16GT1N
T-stuk mof-spie verjongd 67°30	100	BT16GT1B	BT16GT1M	BT16GT1A	BT16GT1N
T-stuk mof-spie 67°30	80	BR16GTB	BR16GTM	BR16GTA	BR16GTN
T-stuk mof-spie 87°30	80	BR18GTB			
Verbindingsmof mof-spie	80	ZRGTB	ZRGTM	ZRGTA	ZRGTN
Verbindingsmof mof-spie verjongd	80	JRGTB	JRGTM	JRGTA	JRGTN

Beugels

CORGTA



CORGT1A

Omschrijving	Ø	Wit	Bruin	Antraciet	Zwart
Pijpbeugel	100	COXGTB *			
Pijpbeugel verborgen bevestiging	100	COTGBB *		COTGBA *	
Pijpbeugel M6	80	CORGB *		CORGA *	
Pijpbeugel p.7/100	80	CORGBB *	CORGBM *	CORGBA *	CORGBN *
Pijpbeugel p.7/150	80	CORGTB *	CORGTM *	CORGTA *	CORGTN *
Pijpbeugel met verborgen bevestiging	100	COTGT1B *	COTGT1M *	COTGT1A *	COTGT1N *
Pijpbeugel met verborgen bevestiging	80	CORGT1B *	CORGT1M *	CORGT1A *	CORGT1N *
Clipbeugel p.7/100	80	CO80GTB *			
Pijpbeugel met verborgen bevestiging p.6/100	80	CORG1AB	CORG1AM	CORG1AA	CORG1AN
Pijpbeugel p.6/100	100	COTG1AB	COTG1AM	COTG1AA	COTG1AN

Accessoires voor afvoerbuizen

1PAF801A



BAO100A



JAM80A



RWS801A



REPF100A



REPTD80A

Omschrijving	Ø	Wit	Bruin	Antraciet	Zwart
Bladvanger	80	1PAF801B	1PAF801M	1PAF801A	1PAF801N
Vergaarbak met overloop (optioneel)	80	BAO80B	BAO80M	BAO80A	BAO80N
Vergaarbak met overloop (optioneel)	100	BAO100B	BAO100M	BAO100A	BAO100N
Ondereind 1 meter lang	80	DDF10RB			
Verzamelbak	80	JAM80B	JAM80M	JAM80A	JAM80N
Uitloop gebogen	80	RWS801B	RWS801M	RWS801A	RWS801N
Uitloop gebogen	100	RWS1001B	RWS1001M	RWS1001A	RWS1001N
Regentonvulautomaat met 1" aansluiting mof-spie verjongd	80	REPTD80B	REPTD80M	REPTD80A	REPTD80N
Regentonvulautomaat met 1" aansluiting mof-spie verjongd	100	REPF100B	REPF100M	REPF100A	REPF100N

LG28 Ovation te lijmen

Profiel dakgoot



LG28A

Lengte	Wit	Beige	Bruin	Antraciet	Zwart
2 m	LG282B	LG282S	LG282M	LG282A	LG282N
4 m	LG28B	LG28S	LG28M	LG28A	LG28N

Hulpstukken voor goot te lijmen



NAD289A

NAD28A

JNC28A

JND28A

AIC28A

AEC28A

FD28A

Omschrijving	Ø	Wit	Beige	Bruin	Antraciet	Zwart
Expansie centraaluitloop spie	80	NAD28B	NAD28S	NAD28M	NAD28A	NAD28N
Expansie centraaluitloop spie	90X56	NAD289B	NAD289S	NAD289M	NAD289A	NAD289N
Verbindingsstuk		JNC28B	JNC28S	JNC28M	JNC28A	JNC28N
Expansiestuk		JND28B	JND28S	JND28M	JND28A	JND28N
Binnenhoekstuk 90°		AIC28B	AIC28S	AIC28M	AIC28A	AIC28N
Binnenhoekstuk 135°		AIC285B	AIC285S	AIC285M	AIC285A	AIC285N
Buitenhoekstuk 90°		AEC28B	AEC28S	AEC28M	AEC28A	AEC28N
Buitenhoekstuk 135°		AEC285B	AEC285S	AEC285M	AEC285A	AEC285N
Eindstuk voor goot rechts		FD28B	FD28S	FD28M	FD28A	FD28N
Eindstuk voor goot links		FG28B	FG28S	FG28M	FG28A	FG28N
Eindstuk voor centraaluitloop rechts		FDC28B	FDC28S	FDC28M	FDC28A	FDC28N
Eindstuk voor centraaluitloop links		FGC28B	FGC28S	FGC28M	FGC28A	FGC28N

Gootbeugels



CRONO28A

INVISI28A

BHGB28A

Omschrijving	Wit	Beige	Bruin	Antraciet	Zwart
Gootbeugel verborgen ophanging met voorgemonteerde schroef	CRONO28B *			CRONO28A *	
Gootbeugel verborgen ophanging	INVISI28B *			INVISI28A *	
Gootbeugel verborgen ophanging	BHGB28B *	BHGB28S *	BHGB28M *	BHGB28A *	BHGB28N *

* Niet uit TECHTAN[®] gemaakt

Afvoerbuizen



TD803PA

TD95A

Omschrijving	Ø	Wit	Beige	Bruin	Antraciet	Zwart
Afvoerbuis 3 m gemoft	80	TD803PB	TD803PS	TD803PM	TD803PA	TD803PN
Afvoerbuis 3 m niet gemoft	80				TD803A	TD803N
Afvoerbuis 4 m gemoft	80	TD80PB	TD80PS	TD80PM	TD80PA	TD80PN
Afvoerbuis 4 m niet gemoft	80	TD80B		TD80M	TD80A	TD80N
Afvoerbuis 3 m	90X56	TD953B	TD953S	TD953M	TD953A	TD953N
Afvoerbuis 4 m	90X56	TD95B	TD95S	TD95M	TD95A	TD95N

Hulpstukken voor afvoerbuizen Ø80



CR4GT1A



CR66GTA



CR6GT1A



BR16GTA



ZR95A



JRGTA

Omschrijving	Ø	Wit	Beige	Bruin	Antraciet	Zwart
Bocht mof-spig 20°	80	CR2GTB	CR2GTS	CR2GTM	CR2GTA	CR2GTN
Bocht mof-spig 45°	80	CR4GTB	CR4GTS	CR4GTM	CR4GTA	CR4GTN
Bocht mof-spig 67°30	80	CR6GTB	CR6GTS	CR6GTM	CR6GTA	CR6GTN
Bocht mof-spig 87°30	80	CR8GTB	CR8GTS	CR8GTM	CR8GTA	CR8GTN
Bocht mof-mof 45°	80	CR44GTB	CR44GTS	CR44GTM		
Bocht mof-mof 67°30	80	CR66GTB	CR66GTS	CR66GTM	CR66GTA	CR66GTN
Bocht mof-mof 87°30	80	CR88GTB	CR88GTS			
Bocht mof-spig verjongd 45°	80	CR4GT1B	CR4GT1S	CR4GT1M	CR4GT1A	CR4GT1N
Bocht mof-spig verjongd 67°30	80	CR6GT1B	CR6GT1S	CR6GT1M	CR6GT1A	CR6GT1N
Bocht mof-spig verjongd 87°30	80	CR8GT1B	CR8GT1S	CR8GT1M	CR8GT1A	CR8GT1N
Bocht mof-spig verjongd 87°30	80	CR8GT1B	CR8GT1S	CR8GT1M	CR8GT1A	CR8GT1N
T-stuk mof-spig 67°30	80	BR16GTB	BR16GTS	BR16GTM	BR16GTA	BR16GTN
T-stuk mof-spig verjongd 67°30	80	BR16GT1B	BR16GT1S	BR16GT1M	BR16GT1A	BR16GT1N
T-stuk mof-spig verjongd 87°30	80	BR18GTB	BR18GTS			
Overgangsstuk stadsuitloop mof-spig verjongd	80	ZR95B	ZR95S	ZR95M	ZR95A	ZR95N
Verbindingsmof mof-spig verjongd	80	JRGTB	JRGTS	JRGTM	JRGTA	JRGTN



Slim opgelost!

Met de verbindingsmof verjongd kun je alle afgezaagde stukken afvoerbuis mooi en netjes gebruiken voor een esthetische verbinding.

Hulpstukken voor afvoerbuizen Ø90x56



CN1GTA



CN9GTA



CNP9GTA



BN16GTA



ZNGTA

Omschrijving	Ø	Wit	Beige	Bruin	Antraciet	Zwart
Bocht mof-spie 15°	90X56	CN1GTB	CN1GTS	CN1GTM	CN1GTA	CN1GTN
Bocht mof-spie 45°	90X56	CN4GTB	CN4GTS	CN4GTM	CN4GTA	CN4GTN
Bocht mof-spie 67°/30	90X56	CN6GTB	CN6GTS	CN6GTM	CN6GTA	CN6GTN
Bocht mof-spie 87°/30	90X56	CN8GTB	CN8GTS	CN8GTM	CN8GTA	CN8GTN
Bocht verticaal mof-spie verjongd 90°	90X56	CN9GTB	CN9GTS	CN9GTM	CN9GTA	CN9GTN
Bocht horizontaal mof-spie verjongd 90°	90X56	CNP9GTB	CNP9GTS	CNP9GTM	CNP9GTA	CNP9GTN
T-stuk mof-spie 67°/30	90X56	BN16GTB	BN16GTS		BN16GTA	BN16GTN
Verbindingsstuk mof-spie verjongd	90X56	ZNGTB	ZNGTS	ZNGTM	ZNGTA	ZNGTN
Verbindingsstuk excentrisch mof	90X56	ZR95BMF	ZR95SMF			

Beugels



CORGTA



CONGTA

Omschrijving	Ø	Wit	Beige	Bruin	Antraciet	Zwart
Clipbeugel p.7/150	80	CO80GTB *	CO80GTS*			
Pijpbeugel p.7/100	80	CORGBB *	CORGBS *	CORGBM *	CORGBA *	CORGBN *
Pijpbeugel p.7/150	80	CORGTB *	CORGTS *	CORGTM *	CORGTA *	CORGTN *
Pijpbeugel M6	80	CORGAB *				
Pijpbeugel met verborgen bevestiging p.6/100	80	CORGIAB *		CORGIAM *	CORGIAA *	CORGIAN *
Pijpbeugel met verborgen bevestiging 7x150	80	CORGT1B *	CORGT1S *	CORGT1M *	CORGT1A *	CORGT1N *
Pijpbeugel	90X56	CONGAB *			CONGAA *	CONGAN *
Clipbeugel	90X56	CONGTB *	CONGTS *		CONGTA *	CONGTN *

Accessoires voor afvoerbuizen



BAO80A



JAM80A



REPTD80A



RWS801A



1PAF801A



JAM95A



PCU95A

Omschrijving	Ø	Wit	Beige	Bruin	Antraciet	Zwart
Vergaarbak met overloop (optioneel)	80	BAO80B	BAO80S	BAO80M	BAO80A	BAO80N
Verzamelbak	80	JAM80B	JAM80S	JAM80M	JAM80A	JAM80N
Bladvanger mof-spie verjongd (in zakje)	80	PAF801B	PAF801S	PAF801M	PAF801A	PAF801N
Regentonvulautomaat met 1" aansluiting mof-spie verjongd	80	REPTD80B	REPTD80S	REPTD80M	REPTD80A	REPTD80N
Uitloop gebogen	80	RWS801B	RWS801S	RWS801M	RWS801A	RWS801N
Bladvanger	80	1PAF801B	1PAF801S	1PAF801M	1PAF801A	1PAF801N
Concentrisch verloop	100-80	RE338GTB	RE338S	RE338GTM	RE338A	RE338N
Verzamelbak	90X56	JAM95B	JAM95S	JAM95M	JAM95A	JAM95N
Overgangsstuk naar rond met voetplaat mof-universeel 90-100-110-125 verjongd	90X56	PCU95B	PCU95S	PCU95M	PCU95A	PCU95N

* Niet uit TECHTAN[®] gemaakt

LG38 Ovation te lijmen

Profiel dakgoot



LG38B

Lengte	Wit	Antraciet	Zwart
2 m	LG382B	LG382A	LG382N
4 m	LG38B	LG38A	LG38N

Hulpstukken voor goot te lijmen



Omschrijving	Ø	Wit	Antraciet	Zwart
Expansie centraaluitloop (spie)	100	NAD38B	NAD38A	NAD38N
Expansie centraaluitloop (spie)	105x76	NAD381B	NAD381A	NAD381N
Verbindingsstuk		JNC38B	JNC38A	JNC38N
Expansiestuk		JND38B	JND38A	JND38N
Binnenhoekstuk 90°		AIC38B	AIC38A	AIC38N
Buitenhoekstuk 90°		AEC38B	AEC38A	AEC38N
Binnenhoekstuk 135°		AIC385B	AIC385A	AIC385N
Buitenhoekstuk 135°		AEC385B	AEC385A	AEC385N
Eindstuk voor goot links		FG38B	FG38A	FG38N
Eindstuk voor goot rechts		FD38B	FD38A	FD38N
Eindstuk voor centraaluitloop links		FGC38B	FGC38A	FGC38N
Eindstuk voor centraaluitloop rechts		FDC38B	FDC38A	FDC38N

Gootbeugels



BHGB38B

GT38PMB

Omschrijving	Wit	Antraciet	Zwart
Gootbeugel verborgen ophanging	BHGB38B	BHGB38A	BHGB38N
Gootbeugel met dakhaak verborgen ophanging	GT38PMB	GT38PMA	GT38PMN

Afvoerbuizen



TD100B



TD1073B

Omschrijving	Ø	Wit	Antraciet	Zwart
Afvoerbuis 4 m niet gemoft	100	TD100B	TD100A	TD100N
Afvoerbuis 4 m gemoft	100	TD100PB	TD100PA	TD100PN
Afvoerbuis 3 m gemoft	100	TD1003PB	TD1003PA	
Afvoerbuis 3 m	105x76	TD1073B	TD1073A	TD1073N
Afvoerbuis 4 m	105x76	TD107B	TD107A	TD107N

Hulpstukken voor afvoerbuizen Ø100



CT2GTB



CT8GT1B



BT16GT1B



JTGTB



ZTGTB

Omschrijving	Ø	Wit	Antraciet	Zwart
Bocht mof-spig 20°	100	CT2GTB		
Bocht mof-spig verjongd 45°	100	CT4GT1B	CT4GT1A	CT4GT1N
Bocht mof-spig 45°	100	CT4GTB	CT4GTA	
Bocht mof-spig 67°30	100	CT6GTB	CT6GTA	
Bocht mof-spig 87°30	100	CT8GTB	CT8GTA	
Bocht mof-spig verjongd 67°30	100	CT6GT1B	CT6GT1A	CT6GT1N
Bocht mof-spig verjongd 87°30	100	CT8GT1B	CT8GT1A	CT8GT1N
T-stuk mof-spig verjongd 67°30	100	BT16GT1B	BT16GT1A	BT16GT1N
T-stuk mof-spig 67°30	100	BT16GTB	BT16GTA	
Verbindingsmof mof-mof	100	JTGTB	JTGTA	JTGTN
Verbindingsmof mof-spig	100	ZTGTB	ZTGTA	ZGTGN

Hulpstukken voor afvoerbuizen Ø105x76

CM1GTB



CM6GTB



CMO6GTB



CMP9GTB



BM16GTB



ZMGTB

Omschrijving	Ø	Wit	Antraciet	Zwart
Bocht mof-spie 15°	105x76	CM1GTB	CM1GTA	CM1GTN
Bocht mof-spie 37°	105x76	CM6GTB	CM6GTA	CM6GTN
Bocht mof-spie 67°/30	105x76	CMO6GTB	CMO6GTA	CMO6GTN
Bocht mof-spie 87°	105x76	CM8GTB	CM8GTA	CM8GTN
Bocht verticaal mof-spie verjongd 90°	105x76	CM9GTB	CM9GTA	CM9GTN
Bocht horizontaal mof-spie verjongd 90°	105x76	CMP9GTB	CMP9GTA	CMP9GTN
T-stuk mof-spie 67°/30	105x76	BM16GTB	BM16GTA	BM16GTN
Verbindingsstuk mof-spie verjongd	105x76	ZMGTB	ZMGTA	ZMGTN
Overgangsstuk stadsuitloop mof-spie verjongd	105x76	ZT107B	ZT107A	ZT107N

Beugels

COTGTB



COMGTB



COMGAB

Omschrijving	Ø	Wit	Antraciet	Zwart
Pijpbeugel	100	COTGBB *	COTGBA *	
Pijpbeugel met verborgen bevestiging	100	COTGT1B *	COTGT1A *	COTGT1N *
Clipbeugel	105x76	COMGTB *	COMGTA *	COMGTN *

Accessoires voor afvoerbuizen

BAO100B



JAM100B



REP107B



PCU107B



BAO107B



JAM107B

Omschrijving	Ø	Wit	Antraciet	Zwart
Vergaarbak met overloop (optioneel)	100	BAO100B	BAO100A	
Ondereind 1 meter lang	100	DDF10T1B	DDF10T1A	
Ondereind met grondplaat 1 meter lang	100	DDF10MB	DDF10MA	DDF10MN
Verzamelbak	100	JAM100B	JAM100A	JAM100N
Regentonvulautomaat met 1" aansluiting mof-spie verjongd	105x76	REP107B	REP107A	
Overgangsstuk met grondplaat	105x76	PCU107B	PCU107A	PCU107N
Vergaarbak	105x76	BAO107B	BAO107A	BAO107N
Verzamelbak	105x76	JAM107B	JAM107A	JAM107N

* Niet uit TECHTAN[®] gemaakt



Platdak oplossingen



BAO95A



BAO80A



BAO100A



CRAP



LAMB25B

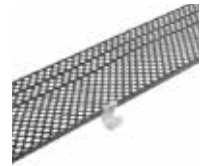

126996

Omschrijving	Ø	Lichtgrijs	Wit	Beige	Bruin	Antraciet	Zwart
Vergaarbak	80	BAO80	BAO80B	BAO80S	BAO80M	BAO80A	BAO80N
Vergaarbak	100	BAO100	BAO100B		BAO100M	BAO100A	BAO100N
Verzamelbak	90x56				BAO95M	BAO95A	BAO95N
Verzamelbak	105x76		BAO107B		BAO107M	BAO107A	BAO107N
Verzameltrechter	100	BAO100-V83					
Bladvanger	80-100	CRAP					
Versierend H=250mm L=50cm			LAMB25B				
Regenwater geleider dakgoot							LARM18N
Bladvanger 2x 2m						126996	

Slim opgelost: beugels voor LG25 - LG33 - LG29



HCL25



HCH25



1EO70G



KEO



EOALI



VI6ETR



CG

Omschrijving	Code
Dakhaak staal gegalvaniseerd 125mm	HCC25
Dakhaak staal gegalvaniseerd 225mm	HCL25
Dakhaak staal gegalvaniseerd 500mm	HCL50
Dakhaak staal gegalvaniseerd gedraaid 225mm	HCH25
Golfdakhaak	EO70G
Golfdakhaak (in zakje)	1EO70G
Wig voor golfdakhaak EO70G	KEO
Draadhaak, verzinkt, type «krokodil»	EOALI
Gegalvaniseerde haak tbv LG25-LG29 en LG33	CG
Gegalvaniseerde haak tbv goot Ovation	CGO
Dakhaak	CP
Golfdakhaak voor Ovation goot	CTO
Golfdakhaak voor dak met golfplaten	EOGCT
Schroeven tbv Ovation LG28/LG38 beugels	VI645ET

Afvoerputten

REDI

 een **alixis** merk

PP hemelwaterafvoerputten

De PP hemelwaterafvoerputten van REDI (grijs, RAL 7037) zijn universeel geschikt voor aansluiting op hemelwaterafvoerbuizen van Ø80 of Ø100mm. Ze hebben een geïntegreerde bladvang en stankafsluiter.

Dankzij de meegeleverde dichte deksel en rooster zijn ze zowel toepasbaar als afvoer-, schrob- en ontlastput. Bovendien functioneren ze als verloopstuk van hemelwaterafvoerbuizen Ø80-Ø100mm naar afvoerbuizen Ø110mm.

Een passende oplossing volgens de regelgeving omtrent het afkoppelen en de mogelijkheid tot overstorten van regenwater; ontworpen en getest volgens EN 1253-1.

Voordelen

- licht in gewicht.
- gemakkelijk te installeren.
- functioneert als ontlastput in combinatie met rooster.
- ontstopingsmogelijkheid door uitneembaar stankslot.
- mogelijkheid de hemelwaterafvoer buis excentrisch aan te sluiten.

Toepassingen

- bestrating/terras.
- trottoir.
- verharde wandelpaden.

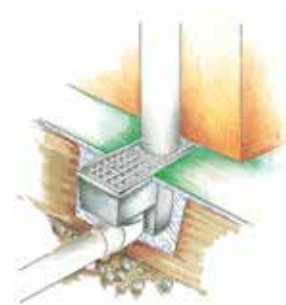
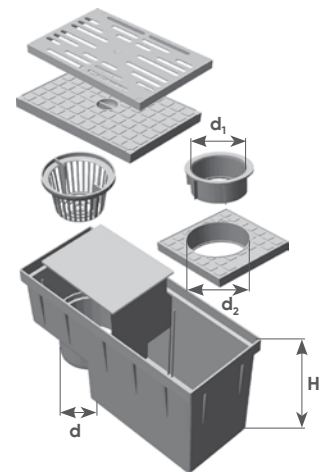

Y772004



Y662004



116185

Omschrijving	Ø	Lichtgrijs	Zwart
Toezichtspuit vierkant 110mm	110	Y772004	
Toezichtspuit ronde 110mm	110	Y662004	
Toezichtspuit met korf		Y663304	Y663304B
Toezichtspuit zonder korf			Y881108

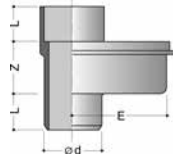

PVC-terrasafvoerput met afneembaar rooster lichtgrijs (RAL 7035)

Code	Afmeting	d	E	Z	L
SB80	125 x 73	80	125	73	50
SB100	115 x 73	100	115	73	50

met uitneembaar waterslot
voor hoekopstelling en als balkondoorrover
1xmf-1xspie



PP-regenwaterbufferput met overstort

Code	Afmeting	d	H
RESV	300 x 300	75/90/110	300

vierkant basiselement met voorgevormde aansluitingen voor buis Ø75, 90 en 110mm



PP-opzetstuk voor regenwaterbufferput

Code	Afmeting	d	H
RERETX	300 x 300	100	150

met voorgevormde aansluitingen voor buis 100mm



PVC-deksel met voorgevormde boveninlaat lichtgrijs (RAL 7035)

Code	Afmeting
CORETX	300 x 300

met voorgevormde aansluitingen voor buis Ø80 of 100mm



PVC-sleufrooster lichtgrijs (RAL 7035)

Code	Afmeting
GR30	300 x 300

klasse A15 = 1.500 kg



PVC-deksel lichtgrijs (RAL 7035)

Code	Afmeting
TR30	300 x 300

klasse A15 = 1.500 kg

PVC-vloerputten



De pvc-vloerputten van Jimten zijn door het hydrodynamisch ontwerp zelfreinigend en hebben een hoge afvoercapaciteit tot 4,00 l/s, afhankelijk van de diameter van de uitlaat. Ze zijn ontworpen en getest volgens EN 1253-1.

Voordelen

- een inwendige verticale uitlaat, waardoor kort gewerkt kan worden.
- het spie-eind is PVC-verlijmbaar.
- robuuste kwaliteit.
- waterslot 50mm volgens bouwbesluit.
- goede stabiliteit bij inbetonneren door ribben aan onderzijde.
- vergrendelbaar rooster.



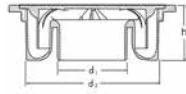

PVC-vloerput met PVC Rooster (RAL7037)

Jimten

Code	Afmeting	d ₁	d ₂	h		Capaciteit in l/s
24060	150 x 150	50	130	90	*	1,36
24100	200 x 200	75	172	90	*	2,42
24090	250 x 250	110	201	97		3,50
24230	300 x 300	125	239	99		4,00

* Klasse L15 = 1.500 kg

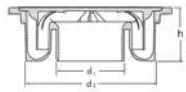

PVC-vloerput met RVS rooster/rand

Jimten

Code	Afmeting	d ₁	d ₂	h		Capaciteit in l/s
24170	150 x 150	50	130	90	*	1,36
24180	200 x 200	75	172	90	*	2,42
24200	250 x 250	110	201	97		3,50
24220	300 x 300	125	239	99		4,00

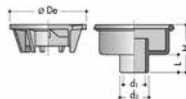

PVC-vloerput antraciet (RAL 7016)

Nicoll

Code	Afmeting	d ₁	d ₂	waterslot	Ø De	L	H	Capaciteit in l/s
SC504	150 x 150	40	50	17	139	32	88	0,94 Ø40 / 0,55 Ø50
SC756	200 x 200	63	75	19,5	179	45	110	1,24 Ø63 / 1,21 Ø75
SK1110	250 x 250	100	110	26	229	61	146	2,03 Ø100 / 2,05 Ø110
SC1110	300 x 300	100	110	50	230	61	183	3,14 Ø100 / 3,10 Ø110

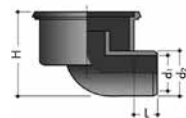

PVC-vloerput antraciet (RAL 7016)

Nicoll

Code	Afmeting	d ₁	d ₂	waterslot	Ø De	L	H	Capaciteit in l/s
SC1925	250 x 250	90	100	50	230	57	192	2,83 Ø90 / 2,82 Ø100
SC1930	300 x 300	90	100	50	230	57	192	2,83 Ø90 / 2,82 Ø100

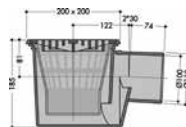

PVC-schrobput antraciet (RAL 7016)

Nicoll

Code	Afmeting	Capaciteit in l/s
SCP1110	200 x 200	1,89 Ø100 / 1,91 Ø110



PVC-vloerput hoog model antraciet (RAL 7016)

Nicoll

Code	Afmeting	d ₁	d ₂	waterslot	Ø De	L	H	Capaciteit in l/s
SC54	150 x 150	40	50	60	139	32	131	1,03 Ø40 / 0,54 Ø50
SC76	200 x 200	63	75	60	179	45	150	2,58 Ø63 / 1,25 Ø75

Aliaxis Nederland B.V.

Industrieterrein 11

Postbus 7149

5980 AC Panningen Nederland

Tel: +31 (0)77 30 88 650

info.nl@aliaxis.com

www.aliaxis.nl

